

ビニル絶縁付丸形端子(ストレート形)

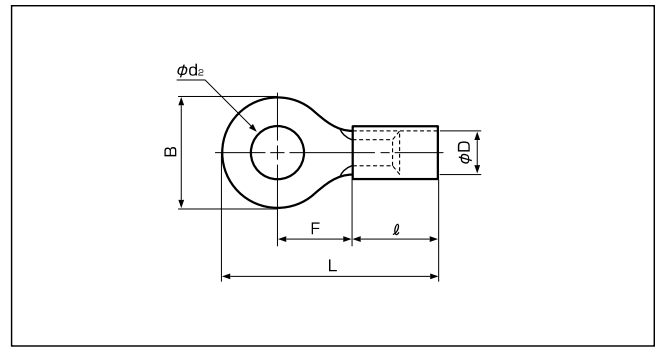

E42024
 LR20812
 JQ0608019
 JIS C 2805

形番	規格	寸法(mm)							標準色	適用電線範囲 撚線(mm ²)	適用圧着工具			1箱 入数 (個)
		φd2	B	L	F	ℓ	φD	板厚			手動	空気圧式	油圧式	
VO.5-2		2.2	5.2	16.4	5.8	8.0	1.9	0.5	黄	0.2~0.5 (0.2 (AWG#24) 0.3 (AWG#22) 0.5	YNT-2622	YA-1, YA-2 YAT-1A YAT-2A YAD-1A YAD-2A	BCT-0514	1,000
VO.5-3		3.2												
VO.5-3.7		3.7	6.6	19.0	7.7									
VO.5-4		4.3												
VO.5-5		5.3	8.0	7.0										
V1.25-2		2.2	5.5	15.7	4.0	9.0	3.2	0.8	赤	※ 0.25~1.65 ※ (0.3 (AWG#22) 0.5 (AWG#20) 0.75 (AWG#18) 0.9 (1.25 (AWG#16))	YNT-2216	YA-1 YA-2 YAT-1A YAT-2A YAD-1A YAD-2A YA-4 YAT-4A YAD-4A	BCT-0514	1,000
V1.25-3(RAV1.25-3)		3.2												
V1.25-MS3		3.2	8.0	20.0	7.0									
V1.25-L3		3.7	5.5	15.7	4.0									
V1.25-3.7		3.7	6.6	18.6	6.3									
V1.25-M3(RAV1.25-3.5)		3.7	8.0	20.0	7.0									
V1.25-M4		4.3	9.0	24.6	11.1									
V1.25-4(RAV1.25-4)		4.3	8.0	20.0	7.0									
V1.25-5NS		5.3	9.0	24.6	11.1									
V1.25-5(RAV1.25-5)		5.3	8.0	20.0	7.0									
V1.25-6		6.4	11.6	25.9	11.1									
V1.25-8		8.4												
V1.25-10		10.5	13.6	29.7	13.9									
V2-S2		2.2	6.4	16.5	4.3	9.0	3.9	0.8	青	1.04~2.63 (1.25 (AWG#16) 2.0 (AWG#14))	YNT-1614	YA-1 YA-2 YAT-1A YAT-2A YAD-1A YAD-2A YA-4 YAT-4A YAD-4A	BCT-0514	1,000
V2-MS3		3.2	5.5	17.4	5.6									
V2-S3.3		3.2	6.4	16.5	4.3									
V2-3		3.7	8.5	21.0	7.8									
V2-S3		3.7	6.4	16.5	4.3									
V2-P3.5		3.7	7.0	20.2	7.7									
V2-M3(RAV2-3.5)		3.7	6.6	18.6	6.3									
V2-M4		4.3	7.0	20.2	7.7									
V2-P4		4.3	8.5	21.0	7.8									
V2-4(RAV2-4)		4.3	9.0	24.5	11.0									
V2-M5		5.3	9.5	21.0	7.3									
V2-5NS		5.3	9.0	24.5	11.0									
V2-5(RAV2-5)		5.3	9.5	21.0	7.3									
V2-6(RAV2-6)		6.4	12.0	26.0	11.0									
V2-8(RAV2-8)		8.4												
V2-10		10.5	13.6	29.7	13.9									
V2-12		13.0	19.0	35.2	16.7									
V2-14		15.0	27.0	43.7	21.2									
V2-16		17.0												
V2-20		21.0												









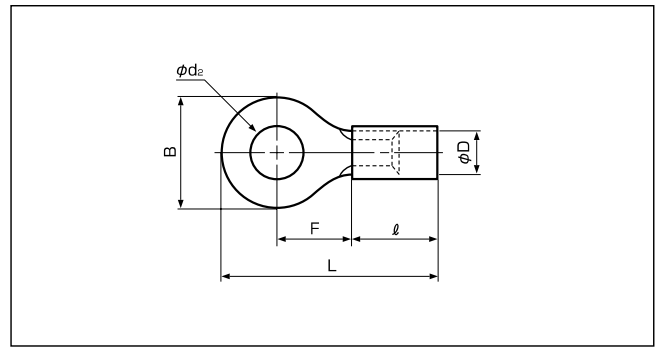



























注1) ()はJIS規格形番を示します。なお、JIS規格形番製品とJST形番製品は同一品です。規格No. JIS C 2805

注2) ※印は電線の合計断面積が0.5mm²以上となる様にして使用すればより確実になります。(例:0.3mm²を2つ折りにして圧着、0.5mm²はそのまま圧着)

注3) 本製品の中には多少納期を要するものもあります。

注4) VO.5-()におけるUL登録の適用電線はAWG#26~AWG#22です。



形番	規格	寸法(mm)							標準色	適用電線範囲		適用圧着工具			1箱 入数 (個)
		φd2	B	L	F	ℓ	φD	板厚		撚線(mm ²)	手動	空気圧式	油圧式		
V5.5-3	 	3.2	9.5	26.5	8.3	13.5	5.4	1.0	黄	2.63~6.64 (3.5(AWG#12) 5.5(AWG#10))	YNT-1210S	YA-4 YAT-4A YAD-4A	BCT-0514	500	
V5.5-S3	 	3.7	7.2	23.0	5.9										
V5.5-S4	 	4.3	9.5	26.5	8.3										
V5.5-4(RAV5.5-4)	  														
V5.5-5(RAV5.5-5)	  	5.3	13.2	29.1	9.0										
V5.5-S5	 														
V5.5-6(RAV5.5-6)	  	6.4	12.0	32.5	13.0										
V5.5-S6	 														
V5.5-S8	 	8.4	13.2	29.1	9.0										
V5.5-8(RAV5.5-8)	  														
V5.5-10(RAV5.5-10)	  	10.5	15.0	34.7	13.7										
V5.5-12	 	13.0	19.2	39.1	16.0										
V5.5-14	 	15.0	32.0	54.8	25.3										
V5.5-16	 	17.0													
V5.5-18	 	19.0													
V5.5-20	 	21.0													
														250	

注1) ()はJIS規格形番を示します。なお、JIS規格形番製品とJST形番製品は同一品です。規格No.JIS C 2805

注2) 本製品の中には多少納期を要するものもあります。